

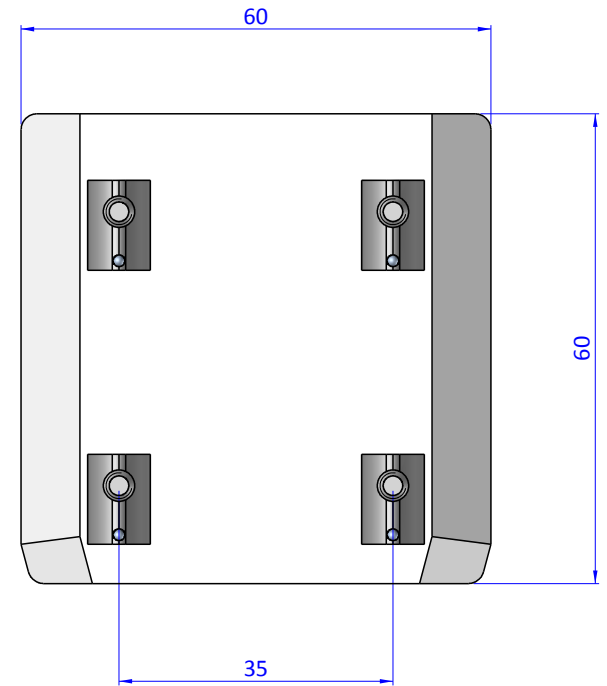

THE PROPERTY OF THE DRAWING IS ESTABLISHED BY LAW. IT IS FORBIDDEN TO PRODUCE OR SHOW IT TO THIRD PARTY, WITHOUT A WRITTEN AGREEMENT.

Item	Name	Qty.
1	CA.02.05.002	4
2	GPM0.X	1
3	R.4.SCH	4
4	V.TCE4x10	4

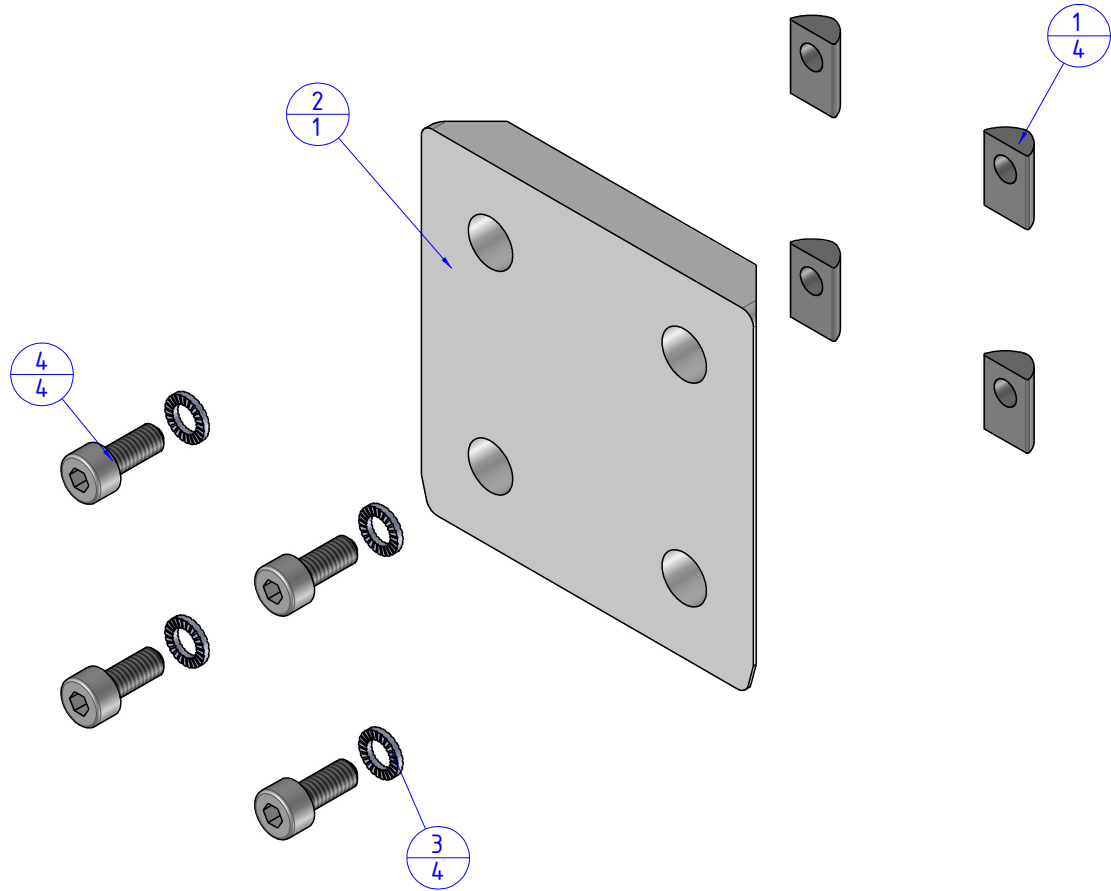

Format A3

UNI 936-76

 <b>FPS</b> FPSERVICES AUTOMATION		DESIGNED FROM		REVIEW
		FPS Automation		A
GENERAL TOLERANCE		DATE	WEIGHT	
UNI - ISO 2768		10/04/2019	0,080kg	
CLASSE f		CODE		
		CA.GPM0.5		CA.GPM0.5